

Scale 1:2

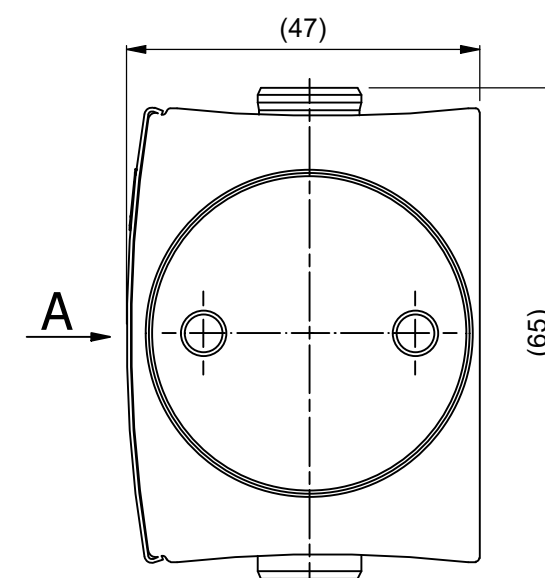

Scale 1:2

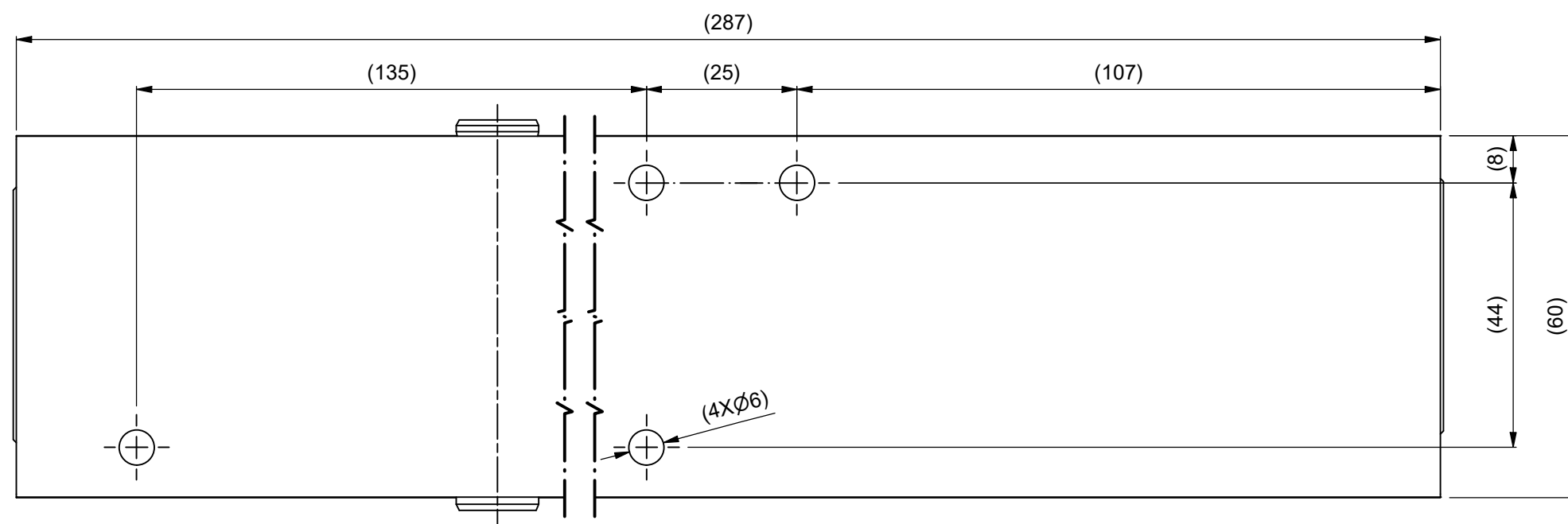
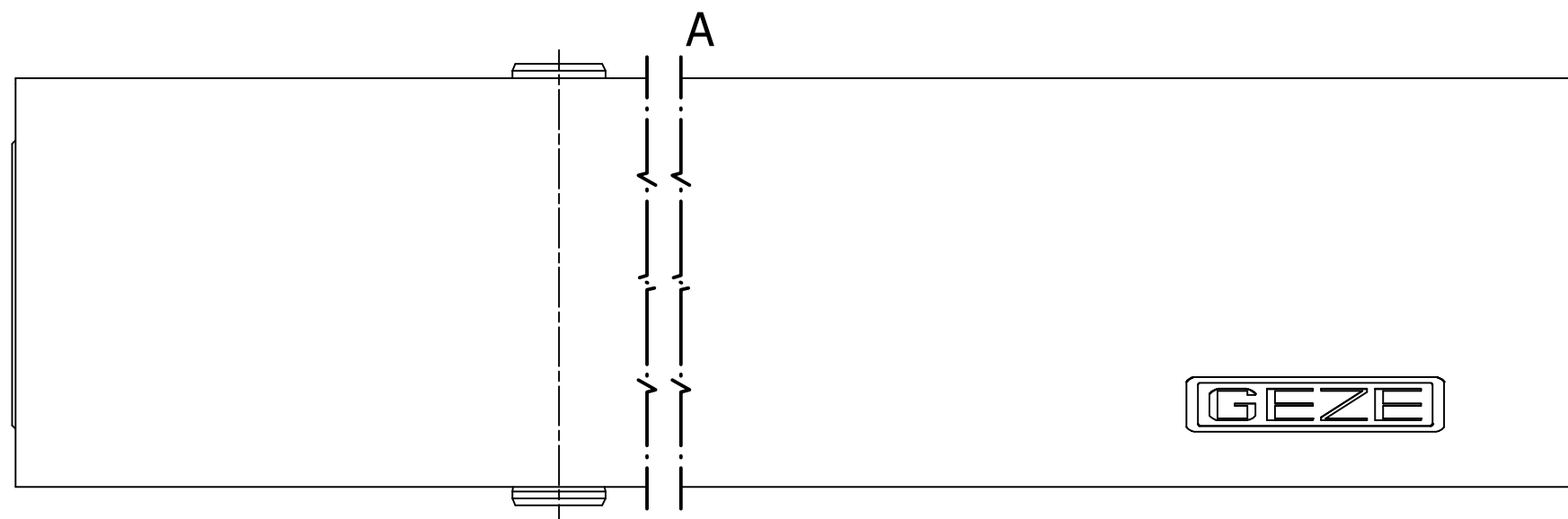
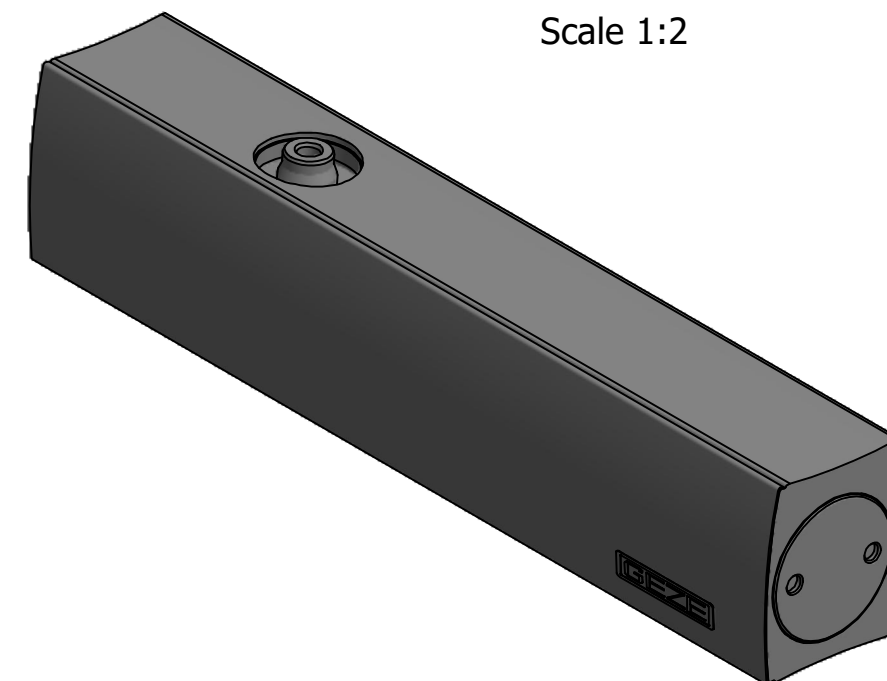
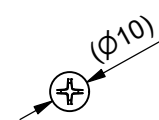
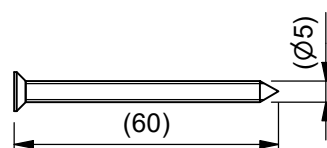
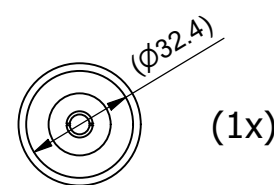
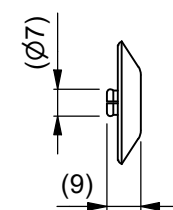

DIN 7982 (ISO 7050) (4x)

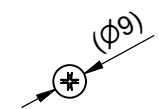
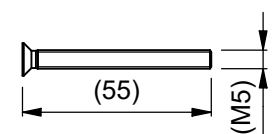

DIN 965 (ISO 7046-1) (4x)

(Indicative Dimensions)

ⓑ
Ⓐ

Name	BEVLADR	SMA	SMA	Unquoted	# = 0.2	% = 0.4	& = 1	+ =	= =	Mark surface treatment →	Mark manufacturer M →
	BEVLADR				SMA	SMA	roundings < R 0.2	\$ = 0.3	* = 0.5		
Date	19/02/2014	A	B	Visible surface		Material		ARTICLE DRAWING ACCESSORIES		Volume mm ³	Revision
	27/04/2022			2/05/2022	primary	secondary	(SEE REMARKS !)	759966 mm ³	B		
Rev	A	B		ISO-symbol	Tolerances	Date		Reynaers Aluminium	Drawing	065.7443.PA	
					DIN 7168m	29/04/2022					
Sheet size	A3		Designed	BEVLADR							
Scale	1:1										